

Dell™ Inspiron™ 7500 System

PORT REPLICATOR USER'S GUIDE



Model PRX

BE DIRECT™
DELL™
www.dell.com

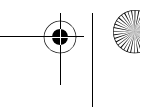
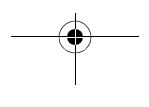
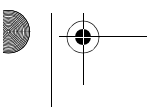
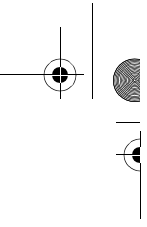
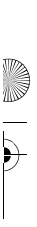

Dell™ Inspiron™ 7500 System

PORT REPLICATOR USER'S GUIDE

Notes, Notices, and Cautions

Throughout this guide, blocks of text may be accompanied by an icon and printed in bold type or in italic type. These blocks are notes, notices, and cautions, and they are used as follows:



NOTE: A **NOTE** indicates important information that helps you make better use of your computer system.

NOTICE: A **NOTICE** indicates either potential damage to hardware or loss of data and tells you how to avoid the problem.



CAUTION: A **CAUTION** indicates a potentially hazardous situation which, if not avoided, may result in minor or moderate injury.

**Information in this document is subject to change without notice.
© 1999 Dell Computer Corporation. All rights reserved.**

Reproduction in any manner whatsoever without the written permission of Dell Computer Corporation is strictly forbidden.

Trademarks used in this text: *Dell*, the *DELL* logo, and *Inspiron* are trademarks and *DellWare* is a service mark of Dell Computer Corporation; *Microsoft*, *MS-DOS*, and *Windows* are registered trademarks of Microsoft Corporation; *Intel* and *Pentium* are registered trademarks and *Celeron* is a trademark of Intel Corporation; *lomega* is a registered trademark of lomega Corporation; *NeoMagic* is a registered trademark and *MagicMedia* is a trademark of NeoMagic Corporation.

Other trademarks and trade names may be used in this document to refer to either the entities claiming the marks and names or their products. Dell Computer Corporation disclaims any proprietary interest in trademarks and trade names other than its own.

September 1999 P/N 5498T Rev. A00



Contents

Connecting External Devices to the Port Replicator	1-1
Connecting the Computer to the Port Replicator	1-3
Detaching the Computer From the Port Replicator	1-4
Using the Network Interface Controller Connector (Optional)	1-5
Technical Specifications	1-6
Regulatory Notices	1-7
FCC Notices (U.S. Only)	1-8
Class A	1-8
Class B	1-9
IC Notice (Canada Only)	1-9
CE Notice (European Union)	1-10
EN 55022 Compliance (Czech Republic Only)	1-10
VCCI Notices (Japan Only)	1-10
Class A ITE	1-11
Class B ITE	1-11
MOC Notice (South Korea Only)	1-11
Class A Device	1-12
Class B Device	1-12
Polish Center for Testing and Certification Notice	1-13
Wymagania Polskiego Centrum Badań i Certyfikacji	1-13
Pozostałe instrukcje bezpieczeństwa	1-13
NOM Information (Mexico Only)	1-14
Información para NOM (únicamente para México)	1-15
Warranty, Return Policy, and Year 2000 Statement of Compliance	1-16
Limited One-Year Warranty (U.S. Only)	1-16
Limited One-Year Warranty (Canada Only)	1-17
"Total Satisfaction" Return Policy (U.S. and Canada Only)	1-19
Year 2000 Statement of Compliance for Dell-Branded Hardware Products	1-19

Previous Products	1-20
Software	1-20
Additional Information	1-21

Figures

Figure 1-1. Attaching External Devices to the Port Replicator.	1-3
Figure 1-2. Positioning the Computer on the Port Replicator	1-4
Figure 1-3. Docking the Computer	1-4
Figure 1-4. Detaching the Computer From the Pass-Through Port Replicator1-5	
Figure 1-5. VCCI Class A ITE Regulatory Mark	1-11
Figure 1-6. VCCI Class B ITE Regulatory Mark	1-11
Figure 1-7. MOC Class A Regulatory Mark	1-12
Figure 1-8. MOC Class B Regulatory Mark	1-12

Tables

Table 1-1. External I/O Connectors	1-2
Table 1-2. Technical Specifications	1-6

Figure 1-1.	Attaching External Devices to the Port Replicator	1-3
Figure 1-2.	Positioning the Computer on the Port Replicator	1-4
Figure 1-3.	Docking the Computer	1-4
Figure 1-4.	Detaching the Computer From the Pass-Through Port Replicator . . .	1-5
Figure 1-5.	VCCI Class A ITE Regulatory Mark	1-11
Figure 1-6.	VCCI Class B ITE Regulatory Mark	1-11
Figure 1-7.	MOC Class A Regulatory Mark	1-12
Figure 1-8.	MOC Class B Regulatory Mark	1-12

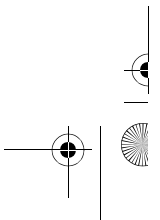
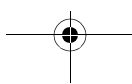
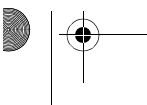
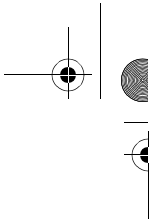

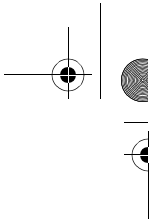
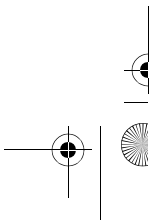
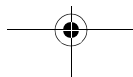
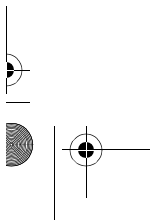
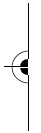
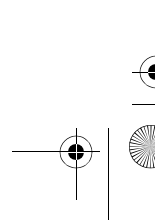
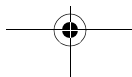
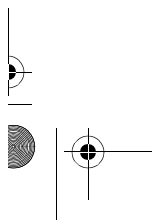
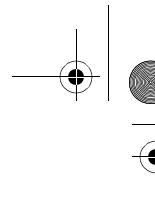

Table 1-1.	External I/O Connectors	1-2
Table 1-2.	Technical Specifications	1-6







Dell™ Inspiron™ 7500 System Port Replicator User's Guide

The port replicator integrates your computer quickly and easily into a desktop environment. Use the instructions in this document to attach external devices to the port replicator and to connect your computer to the port replicator.

Two types of port replicators are available for your computer: advanced and pass-through. The *advanced port replicator (APR)* has a network interface controller (NIC). To connect the computer to a network, you must have a NIC in your computer. If you are using the advanced port replicator, another PC Card NIC is not required. However, the *pass-through port replicator* does not have a NIC, so you must install a PC Card NIC in your computer.













NOTE: If you received a basic input/output system (BIOS) upgrade diskette with your port replicator, use the diskette to upgrade the BIOS on your computer before attaching the computer to the port replicator. For instructions, see the document that came with the BIOS upgrade diskette.

NOTICE: Do not attempt to lift the computer while it is docked in the port replicator. Doing so will damage the docking connector. For instructions, refer to "Detaching the Computer From the Port Replicator" found later in this guide.

Connecting External Devices to the Port Replicator

The input/output (I/O) connectors on the back of the port replicator duplicate the primary connectors on the back and side of your computer. Table 1-1 shows the icons for each of the connectors on the back of the port replicator and indicates the type of external device(s) that you can attach to each connector.

Table 1-1. External I/O Connectors

Connector Icons	Connector Description
	The AC adapter that came with the port replicator connects to the AC adapter connector.
	A PS/2 mouse connects to the PS/2-compatible mouse connector.
	A PS/2 keyboard or external numeric keypad connects to the PS/2-style keyboard connector.
IOIOI	A serial device, such as a serial mouse or external modem, connects to the serial port connector.
	A parallel device, such as a printer, connects to the parallel port connector.
	An external monitor connects to the video connector.
	A television connects to the TV-out S-video connector.
	One or two USB devices, such as a USB mouse, connect to the dual USB connector.
	A network interface cable connects to the NIC connector (optional).
SPDIF	External speakers or home audio equipment connect to the SPDIF audio output connector.
	A record/playback audio device, such as a cassette player, CD player, or VCR, connects to the line-in connector.
	A microphone connects to the microphone-in connector.
	Headphones or a speaker connect to the line-out connector

NOTE: For the full name of an abbreviation or acronym used in this table, see the Glossary in the system Help.

To attach external devices to the port replicator, perform the following steps:

1. Refer to Figure 1-1 to attach external devices to the appropriate connectors on the back of the port replicator.



NOTES: If the cable connector from the external device has thumbscrews, be sure to tighten them to ensure a proper connection.

The port replicators do not provide small computer system interface (SCSI) support. To connect the computer to a SCSI device, you must attach a SCSI card to your computer. See "PC Cards" in the system Help for information about using PC Cards.

For detailed information on using external devices with your computer, see "Connecting External Devices" in the system Help.

2. Connect the external devices to an electrical outlet, if applicable.

Connecting the Computer to the Port Replicator

1. Save and close all open files, exit all open application programs, and shut down the computer.
2. If you have not already done so, connect the AC adapter to the AC adapter connector on the port replicator (see Figure 1-1), and plug the AC power cable into an electrical outlet.

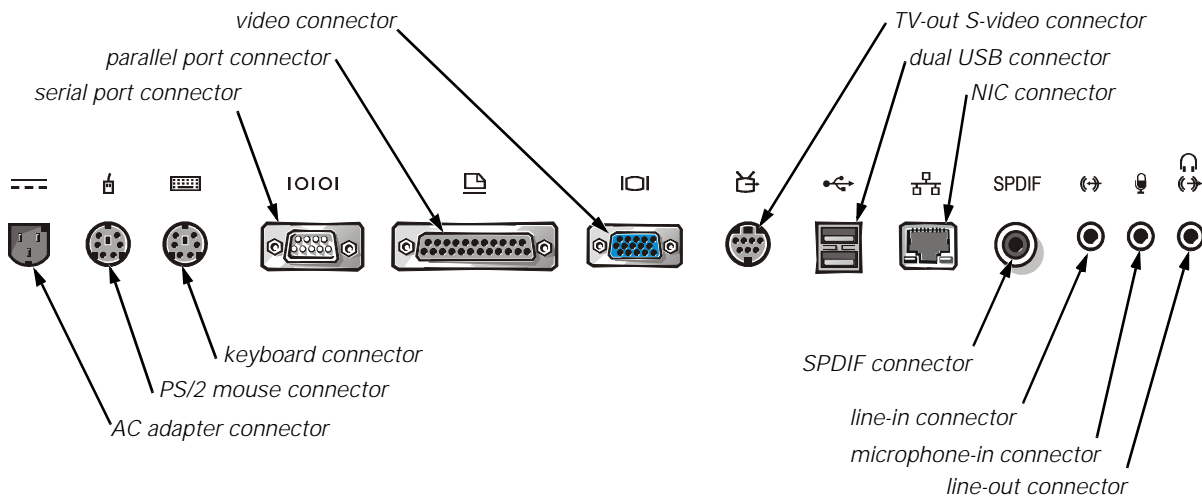

Figure 1-1. Attaching External Devices to the Port Replicator

3. Place the computer on the port replicator platform, with the back of the computer facing the port replicator's docking connector, as shown in Figure 1-2.

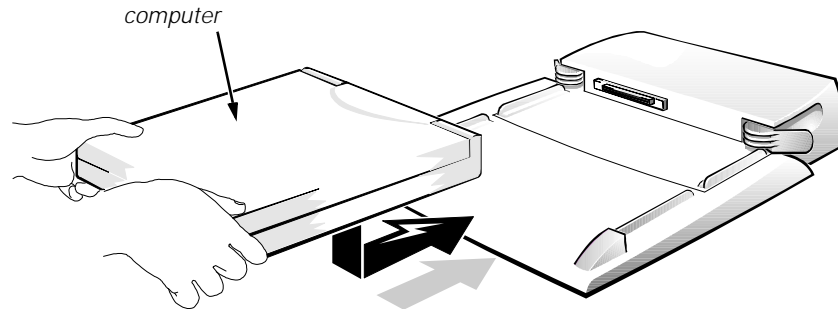

Figure 1-2. Positioning the Computer on the Port Replicator

4. Position your fingers on the platform grips, as shown in Figure 1-3, and use your thumbs to push the computer forward until the docking connectors are fully engaged.

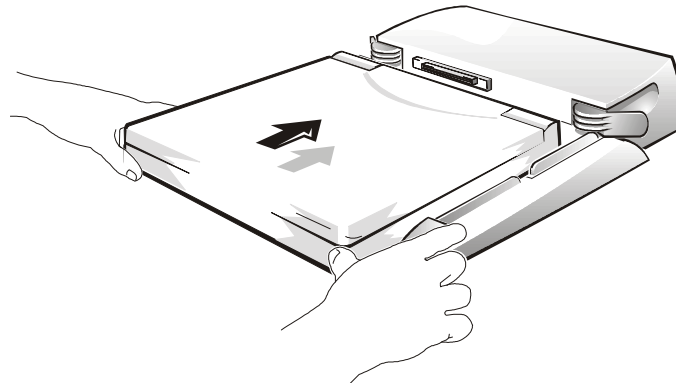

Figure 1-3. Docking the Computer

5. Turn on the computer.

Detaching the Computer From the Port Replicator

Perform the following steps to detach the computer from the APR. The APR has a power button and a safe undock button located on the right side of the port replicator.



NOTE: Do not use the power button located on the APR to turn off your computer while it is attached to the APR. Doing so could result in data loss. Use the power button on the APR to turn on the computer only after it is attached to the APR.

1. Save and close all open files and exit all open application programs.
2. Prior to detaching the computer from the APR, either suspend the power to the computer by pressing the safe undock button, or shut down the Microsoft® Windows® operating system to power off the computer.
3. Pull both of the release handles on the sides of the advanced port replicator to undock the computer.

Perform the following steps to detach the computer from a *pass-through port replicator*:

1. Save and close all open files, exit all open application programs, and shut down the computer.
2. Pull both of the release handles on the sides of the port replicator, as shown in Figure 1-4, to undock the computer.

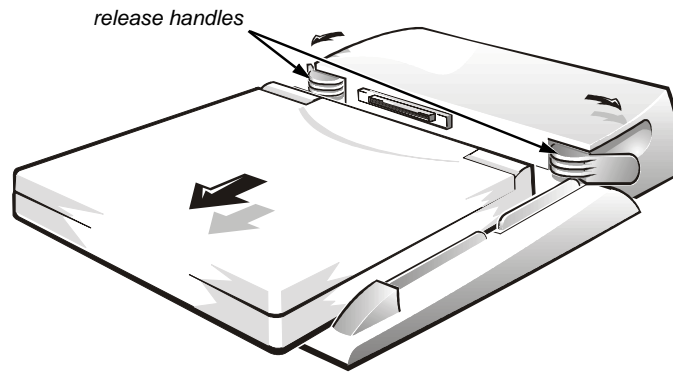

Figure 1-4. Detaching the Computer From the Pass-Through Port Replicator

Using the Network Interface Controller Connector (Optional)

The port replicator may have a NIC connector, which provides network capability. To establish a network connection, refer to the *Quick Start Guide* for instructions on using the NIC.

Technical Specifications

Table 1-2 lists the technical specifications for the port replicator.

Table 1-2. Technical Specifications

Physical	
Height	80 mm (3.15 inches)
Depth	430.0 mm (16.93 inches)
Width	400.0 mm (15.75 inches)
Weight	1.44 kg (3.17 lb)
Connectors	
Serial (DTE)	9-pin connector
Parallel	25-pin connector
PS/2-style keyboard/keypad	6-hole PS/2 keyboard connector
PS/2-compatible mouse	6-hole PS/2 mouse connector
Video	15-hole connector
Audio	one line-out connector, one line-in connector, and one microphone-in connector
USB (dual)	two 4-pin connectors
DC-IN	one connector
Docking	240-pin connector
SPDIF (RCA)	one connector
Network	RJ-45 connector
TV-out	S-video connector
Environmental	
Operating temperature	0° to 35°C (32° to 95°F)
Storage temperature	-20° to 65°C (-4° to 149°F)
Storage relative humidity	20% to 90% (noncondensing)
Altitude (Operating)	sea level 0–10,000 ft
Altitude (Storage)	sea level 0–40,000 ft

NOTE: For the full name of an abbreviation or acronym used in this table, see the Glossary in the system Help.

Regulatory Notices

Electromagnetic Interference (EMI) is any signal or emission, radiated in free space or conducted along power or signal leads, that endangers the functioning of a radio navigation or other safety service or seriously degrades, obstructs, or repeatedly interrupts a licensed radio communications service. Radio communications services include but are not limited to AM/FM commercial broadcast, television, cellular services, radar, air-traffic control, pager, and Personal Communication Services (PCS). These licensed services, along with unintentional radiators such as digital devices, including computer systems, contribute to the electromagnetic environment.

Electromagnetic Compatibility (EMC) is the ability of items of electronic equipment to function properly together in the electronic environment. While this computer system has been designed and determined to be compliant with regulatory agency limits for EMI, there is no guarantee that interference will not occur in a particular installation. If this equipment does cause interference with radio communications services, which can be determined by turning the equipment off and on, you are encouraged to try to correct the interference by one or more of the following measures:

- Reorient the receiving antenna.
- Relocate the computer with respect to the receiver.
- Move the computer away from the receiver.
- Plug the computer into a different outlet so that the computer and the receiver are on different branch circuits.

If necessary, consult a Technical Support representative of Dell Computer Corporation or an experienced radio/television technician for additional suggestions. You may find the *FCC Interference Handbook, 1986*, to be helpful. It is available from the U.S. Government Printing Office, Washington, DC 20402, Stock No. 004-000-00450-7 or on the World Wide Web at <http://www.fcc.gov/Bureaus/Compliance/WWW/tvibook.html>.

Dell computer systems are designed, tested, and classified for their intended electromagnetic environment. These electromagnetic environment classifications generally refer to the following harmonized definitions:

- Class A is for business or industrial environments.
- Class B is for residential environments.

Information Technology Equipment (ITE), including peripherals, expansion cards, printers, input/output (I/O) devices, monitors, and so on, that are integrated into or connected to the system should match the electromagnetic environment classification of the computer system.

A Notice About Shielded Signal Cables: Use only shielded cables for connecting peripherals to any Dell device to reduce the possibility of interference with radio communications services. Using shielded cables ensures that you maintain the appropriate EMC classification for the intended environment. For parallel printers, a cable is available from Dell Computer Corporation. If you prefer, you can order a cable from Dell

Computer Corporation on the World Wide Web at <http://www.dell.com/products/dellware/index.htm>.

A Notice About Networked Computer Systems: Some Dell computer systems that are classified for Class B environments may include an on-board network interface controller (NIC). If your Class B system contains a NIC, it may be considered to be a Class A system at the time that the NIC is connected to a network. When the NIC is not connected to a network, your system is considered to be a Class B digital device.

Most Dell computer systems are classified for Class B environments. To determine the electromagnetic classification for your system or device, refer to the following sections specific for each regulatory agency. Each section provides country-specific EMC/EMI or product safety information.

FCC Notices (U.S. Only)

Most Dell computer systems are classified by the Federal Communications Commission (FCC) as Class B digital devices. However, the inclusion of certain options can change the rating of some configurations to Class A. To determine which classification applies to your computer system, examine all FCC registration labels located on the bottom or back panel of your computer, on card-mounting brackets, and on the cards themselves. If any one of the labels carries a Class A rating, your entire system is considered to be a Class A digital device. If *all* labels carry either the Class B rating distinguished by either an FCC ID number or the FCC logo, (**FC**), your system is considered to be a Class B digital device.

Once you have determined your system's FCC classification, read the appropriate FCC notice. Note that FCC regulations provide that changes or modifications not expressly approved by Dell Computer Corporation could void your authority to operate this equipment.

This device complies with Part 15 of the FCC Rules. Operation is subject to the following two conditions:

- This device may not cause harmful interference.
- This device must accept any interference received, including interference that may cause undesired operation.

Class A

This equipment has been tested and found to comply with the limits for a Class A digital device pursuant to Part 15 of the FCC Rules. These limits are designed to provide reasonable protection against harmful interference when the equipment is operated in a commercial environment. This equipment generates, uses, and can radiate radio frequency energy and, if not installed and used in accordance with the manufacturer's instruction manual, may cause harmful interference with radio communications. Operation of this equipment in a residential area is likely to cause harmful interference, in which case you will be required to correct the interference at your own expense.

Class B

This equipment has been tested and found to comply with the limits for a Class B digital device pursuant to Part 15 of the FCC Rules. These limits are designed to provide reasonable protection against harmful interference in a residential installation. This equipment generates, uses, and can radiate radio frequency energy and, if not installed and used in accordance with the manufacturer's instruction manual, may cause interference with radio communications. However, there is no guarantee that interference will not occur in a particular installation. If this equipment does cause harmful interference to radio or television reception, which can be determined by turning the equipment off and on, you are encouraged to try to correct the interference by one or more of the following measures:

- Reorient or relocate the receiving antenna.
- Increase the separation between the equipment and the receiver.
- Connect the equipment into an outlet on a circuit different from that to which the receiver is connected.
- Consult the dealer or an experienced radio/television technician for help.

The following information is provided on the device or devices covered in this document in compliance with FCC regulations:

- Model number: TSR9C
- Company name: Dell Computer Corporation
EMC Engineering Department
One Dell Way
Round Rock, Texas 78682 USA
512-338-4400

IC Notice (Canada Only)

Most Dell portable computers (and other Dell digital apparatus) are classified by the Industry Canada (IC) Interference-Causing Equipment Standard #3 (ICES-003) as Class B digital devices. To determine which classification (Class A or B) applies to your computer system (or other Dell digital apparatus), examine all registration labels located on the bottom or the back panel of your computer (or other digital apparatus). A statement in the form of "IC Class A ICES-3" or "IC Class B ICES-3" will be located on one of these labels. Note that Industry Canada regulations provide that changes or modifications not expressly approved by Dell Computer Corporation could void your authority to operate this equipment.

This Class B (or Class A, if so indicated on the registration label) digital apparatus meets the requirements of the Canadian Interference-Causing Equipment Regulations.

Cet appareil numérique de la Classe B (ou Classe A, si ainsi indiqué sur l'étiquette d'enregistrement) respecte toutes les exigences du Règlement sur le Matériel Brouilleur du Canada.

CE Notice (European Union)

Marking by the symbol  indicates compliance of this Dell system to the EMC Directive and the Low Voltage Directive of the European Union. Such marking is indicative that this Dell system meets the following technical standards:

- EN 55022 — “Limits and Methods of Measurement of Radio Interference Characteristics of Information Technology Equipment.”
- EN 50082-1: 1992 — “Electromagnetic compatibility—Generic immunity standard Part 1: Residential, commercial, and light industry.”
- EN 60950 — “Safety of Information Technology Equipment.”



NOTE: EN 55022 emissions requirements provide for two classifications:

- *Class A is for typical commercial areas.*
- *Class B is for typical domestic areas.*

This Dell device is classified for use in a typical Class B domestic environment.

A “Declaration of Conformity” in accordance with the preceding directives and standards has been made and is on file at Dell Products Europe BV, Limerick, Ireland.

EN 55022 Compliance (Czech Republic Only)

This device belongs to Class B devices as described in EN 55022, unless it is specifically stated that it is a Class A device on the specification label. The following applies to devices in Class A of EN 55022 (radius of protection up to 30 meters). The user of the device is obliged to take all steps necessary to remove sources of interference to telecommunication or other devices.

Pokud není na typovém štítku počítače uvedeno, že spadá do třídy A podle EN 55022, spadá automaticky do třídy B podle EN 55022. Pro zařízení zařazená do třídy A (ochranné pásmo 30m) podle EN 55022 platí následující. Dojde-li k rušení telekomunikačních nebo jiných zařízení, je uživatel povinen provést taková opatření, aby rušení odstranil.

VCCI Notices (Japan Only)

Most Dell computer systems are classified by the Voluntary Control Council for Interference (VCCI) as Class B information technology equipment (ITE). However, the inclusion of certain options can change the rating of some configurations to Class A. ITE, including peripherals, expansion cards, printers, input/output (I/O) devices, monitors, and so on, integrated into or connected to the system, should match the electromagnetic environment classification (Class A or B) of the computer system.

To determine which classification applies to your computer system, examine the regulatory labels/markings (see Figures 1-5 and 1-6) located on the bottom or back panel of your computer. Once you have determined your system’s VCCI classification, read the appropriate VCCI notice.

Class A ITE

この装置は、情報処理装置等電波障害自主規制協議会 (VCCI) の基準に基づくクラス A 情報技術装置です。この装置を家庭環境で使用すると電波妨害を引き起こすことがあります。この場合には使用者が適切な対策を講ずるよう要求されることがあります。

This is a Class A product based on the standard of the Voluntary Control Council for Interference (VCCI) for information technology equipment. If this equipment is used in a domestic environment, radio disturbance may arise. When such trouble occurs, the user may be required to take corrective actions.

VCCI-A

Figure 1-5. VCCI Class A ITE Regulatory Mark

Class B ITE

この装置は、情報処理装置等電波障害自主規制協議会 (VCCI) の基準に基づくクラス B 情報技術装置です。この装置は家庭環境で使用することを目的としていますが、この装置がラジオやテレビジョン受信機に近接して使用させると、受信障害を引き起こすことがあります。取扱説明書に従って正しい取り扱いをして下さい。

This is a Class B product based on the standard of the Voluntary Control Council for Interference (VCCI) for information technology equipment. If this equipment is used near a radio or television receiver in a domestic environment, it may cause radio interference. Install and use the equipment according to the instruction manual.



Figure 1-6. VCCI Class B ITE Regulatory Mark

MOC Notice (South Korea Only)

To determine which classification (Class A or B) applies to your computer system (or other Dell digital device), examine the South Korean Ministry of Communications (MOC) registration labels located on your computer (or other Dell digital device). The MOC label may be located separately from the other regulatory marking applied to your product. The English text, "EMI (A)," for Class A products, or "EMI (B)" for Class B products, appears in the center of the MOC label (see Figures 1-7 and 1-8).



NOTE: MOC emissions requirements provide for two classifications:

- Class A devices are for business purposes.
- Class B devices are for nonbusiness purposes.

Class A Device

장치 종류	사용자 안내문
A 급 기기	이 장치는 업무용으로 전자파 적합등록을 한 장치이오니 판매자 또는 사용자는 이 점을 주의하시기 바라며 만약 잘못 판매 또는 구입하였을 때에는 가정용으로 교환하시기 바랍니다.

Please note that this device has been approved for business purposes with regard to electromagnetic interference. If you find that this device is not suitable for your use, you may exchange it for a nonbusiness device.

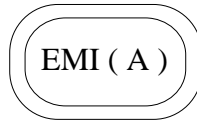

Figure 1-7. MOC Class A Regulatory Mark

Class B Device

장치 종류	사용자 안내문
B 급 기기	이 장치는 가정용으로 전자파 적합등록을 한 장치로서 주거지역에서는 물론 모든 지역에서 사용할 수 있습니다.

Please note that this device has been approved for nonbusiness purposes and may be used in any environment, including residential areas.

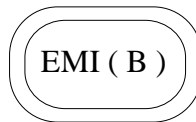

Figure 1-8. MOC Class B Regulatory Mark

Polish Center for Testing and Certification Notice

The equipment should draw power from a socket with an attached protection circuit (a three-prong socket). All equipment that works together (computer, monitor, printer, and so on) should have the same power supply source.

The phasing conductor of the room's electrical installation should have a reserve short-circuit protection device in the form of a fuse with a nominal value no larger than 16 amperes (A).

To completely switch off the equipment, the power supply cable must be removed from the power supply socket, which should be located near the equipment and easily accessible.

A protection mark "B" confirms that the equipment is in compliance with the protection usage requirements of standards PN-93/T-42107 and PN-89/E-06251.

Wymagania Polskiego Centrum Badań i Certyfikacji

Urządzenie powinno być zasilane z gniazda z przyłączonym obwodem ochronnym (gniazdo z kołkiem). Współpracujące ze sobą urządzenia (komputer, monitor, drukarka) powinny być zasilane z tego samego źródła.

Instalacja elektryczna pomieszczenia powinna zawierać w przewodzie fazowym rezerwową ochronę przed zwarciami, w postaci bezpiecznika o wartości znamionowej nie większej niż 16A (amperów).

W celu całkowitego wyłączenia urządzenia z sieci zasilania, należy wyjąć wtyczkę kabla zasilającego z gniazdka, które powinno znajdować się w pobliżu urządzenia i być łatwo dostępne.

Znak bezpieczeństwa "B" potwierdza zgodność urządzenia z wymaganiami bezpieczeństwa użytkowania zawartymi w PN-93/T-42107 i PN-89/E-06251.

Pozostałe instrukcje bezpieczeństwa

- Nie należy używać wtyczek adapterowych lub usuwać kołka obwodu ochronnego z wtyczki. Jeżeli konieczne jest użycie przedłużacza to należy użyć przedłużacza 3-żyłowego z prawidłowo połączonym przewodem ochronnym.
- System komputerowy należy zabezpieczyć przed nagłymi, chwilowymi wzrostami lub spadkami napięcia, używając eliminatora przepięć, urządzenia dopasowującego lub bezzakłócenowego źródła zasilania.
- Należy upewnić się, aby nic nie leżało na kablach systemu komputerowego, oraz aby kable nie były umieszczone w miejscu, gdzie można byłoby na nie nadeptywać lub potykać się o nie.
- Nie należy rozlewać napojów ani innych płynów na system komputerowy.
- Nie należy wpychać żadnych przedmiotów do otworów systemu komputerowego, gdyż może to spowodować pożar lub porażenie prądem, poprzez zwarcie elementów wewnętrznych.
- System komputerowy powinien znajdować się z dala od grzejników i źródeł ciepła. Ponadto, nie należy blokować otworów wentylacyjnych. Należy unikać kładzenia luźnych papierów pod komputer oraz umieszczania komputera w ciasnym miejscu bez możliwości cyrkulacji powietrza wokół niego.

NOM Information (Mexico Only)

The following information is provided on the device(s) described in this document in compliance with the requirements of the official Mexican standards (NOM):

Exporter:	Dell Computer Corporation One Dell Way Round Rock, TX 78682
Importer:	Dell Computer de México, S.A. de C.V. Rio Lerma No. 302 - 4° Piso Col. Cuauhtemoc 16500 México, D.F.
Ship to:	Dell Computer de México, S.A. de C.V. al Cuidado de Kuehne & Nagel de México S. de R.l. Avenida Soles No. 55 Col. Peñon de los Baños 15520 México, D.F.
Supply voltage:	100-240 VAC
Frequency:	50-60 Hz
Input current rating:	6.0/3.0 A

Información para NOM (únicamente para México)

La información siguiente se proporciona en el dispositivo o en los dispositivos descritos en este documento, en cumplimiento con los requisitos de la Norma Oficial Mexicana (NOM):

Exportador:	Dell Computer Corporation One Dell Way Round Rock, TX 78682
Importador:	Dell Computer de México, S.A. de C.V. Rio Lerma No. 302 - 4° Piso Col. Cuauhtemoc 16500 México, D.F.
Embarcar a:	Dell Computer de México, S.A. de C.V. al Cuidado de Kuehne & Nagel de México S. de R.I. Avenida Soles No. 55 Col. Peñon de los Baños 15520 México, D.F.
Tensión alimentación:	100-240 VAC
Frecuencia:	60-50 Hz
Consumo de corriente:	6.0/3.0 A

Warranty, Return Policy, and Year 2000 Statement of Compliance

Limited One-Year Warranty (U.S. Only)

Dell Computer Corporation ("Dell") manufactures its hardware products from parts and components that are new or equivalent to new in accordance with industry-standard practices. Dell warrants that the hardware products it manufactures will be free from defects in materials and workmanship. The warranty term is one year beginning on the date of invoice, as further described in the following text.

Damage due to shipping the products to you is covered under this warranty. Otherwise, this warranty does not cover damage due to external causes, including accident, abuse, misuse, problems with electrical power, servicing not authorized by Dell, usage not in accordance with product instructions, failure to perform required preventive maintenance, and problems caused by use of parts and components not supplied by Dell.

This warranty does not cover any items that are in one or more of the following categories: software; external devices (except as specifically noted); accessories or parts added to a Dell system after the system is shipped from Dell; accessories or parts added to a Dell system through Dell's system integration department; accessories or parts that are not installed in the Dell factory; or DellWareSM products. Monitors, keyboards, and mice that are Dell-branded or that are included on Dell's standard price list are covered under this warranty; all other monitors, keyboards, and mice (including those sold through the DellWare program) are not covered.

Dell will repair or replace products covered under this limited warranty that are returned to Dell's facility. To request warranty service, you must call Dell's Customer Technical Support within the warranty period. Refer to the chapter titled "Getting Help" in your system's troubleshooting documentation or the section titled "Contacting Dell" in your system's *Help* to find the appropriate telephone number for obtaining customer assistance. If warranty service is required, Dell will issue a Return Material Authorization Number. You must ship the products back to Dell in their original or equivalent packaging, prepay shipping charges, and insure the shipment or accept the risk of loss or damage during shipment. Dell will ship the repaired or replacement products to you (freight prepaid) if you use an address in the continental U.S., where applicable. Shipments to other locations will be made freight collect.



NOTE: Before you ship the product(s) to Dell, back up the data on the hard-disk drive(s) and any other storage device(s) in the product(s). Remove any removable media, such as diskettes, CDs, or PC Cards.

Dell owns all parts removed from repaired products. Dell uses new and reconditioned parts made by various manufacturers in performing warranty repairs and building replacement products. If Dell repairs or replaces a product, its warranty term is not extended.

THIS WARRANTY GIVES YOU SPECIFIC LEGAL RIGHTS WHICH VARY FROM STATE TO STATE (OR JURISDICTION TO JURISDICTION). DELL'S RESPONSIBILITY FOR

MALFUNCTIONS AND DEFECTS IN HARDWARE IS LIMITED TO REPAIR AND REPLACEMENT AS SET FORTH IN THIS WARRANTY STATEMENT. ALL EXPRESS AND IMPLIED WARRANTIES FOR THE PRODUCT, INCLUDING BUT NOT LIMITED TO ANY IMPLIED WARRANTIES OF AND CONDITIONS OF MERCHANTABILITY AND FITNESS FOR A PARTICULAR PURPOSE, ARE LIMITED IN DURATION TO THE WARRANTY PERIOD SET FORTH ABOVE AND NO WARRANTIES, WHETHER EXPRESS OR IMPLIED, WILL APPLY AFTER SUCH PERIOD.

SOME STATES (OR JURISDICTIONS) DO NOT ALLOW LIMITATIONS ON HOW LONG AN IMPLIED WARRANTY LASTS, SO THE PRECEDING LIMITATION MAY NOT APPLY TO YOU.

DELL DOES NOT ACCEPT LIABILITY BEYOND THE REMEDIES SET FORTH IN THIS WARRANTY STATEMENT OR LIABILITY FOR INCIDENTAL OR CONSEQUENTIAL DAMAGES, INCLUDING WITHOUT LIMITATION ANY LIABILITY FOR PRODUCTS NOT BEING AVAILABLE FOR USE OR FOR LOST DATA OR SOFTWARE.

SOME STATES (OR JURISDICTIONS) DO NOT ALLOW THE EXCLUSION OR LIMITATION OF INCIDENTAL OR CONSEQUENTIAL DAMAGES, SO THE PRECEDING EXCLUSION OR LIMITATION MAY NOT APPLY TO YOU.

These provisions apply to Dell's limited one-year warranty only. For provisions of any service contract covering your system, refer to your invoice or the separate service contract that you will receive.

If Dell elects to exchange a product or portion of a product, the exchange will be made in accordance with Dell's Exchange Policy in effect on the date of the exchange. In any instance in which Dell issues a Return Material Authorization Number, Dell must receive the product(s) for repair prior to the expiration of the warranty period in order for the repair(s) to be covered by the warranty.

Limited One-Year Warranty (Canada Only)

Dell Computer Corporation ("Dell") manufactures its hardware products from parts and components that are new or equivalent to new in accordance with industry-standard practices. Dell warrants that the hardware products it manufactures will be free from defects in materials and workmanship. The warranty term is one year beginning on the date of invoice, as further described in the following text.

Damage due to shipping the products to you is covered under this warranty. Otherwise, this warranty does not cover damage due to external causes, including accident, abuse, misuse, problems with electrical power, servicing not authorized by Dell, usage not in accordance with product instructions, failure to perform required preventive maintenance, and problems caused by use of parts and components not supplied by Dell.

This warranty does not cover any items that are in one or more of the following categories: software; external devices (except as specifically noted); accessories or parts added to a Dell system after the system is shipped from Dell; accessories or parts added to a Dell system through Dell's system integration department; accessories or parts that are not installed in the Dell factory; or DellWare products. Monitors, keyboards, and mice that are Dell-branded or that are included on Dell's standard price list

are covered under this warranty; all other monitors, keyboards, and mice (including those sold through the DellWare program) are not covered.

Dell will repair or replace products covered under this limited warranty that are returned to Dell's facility. To request warranty service, you must call Dell's Customer Technical Support within the warranty period. Refer to the chapter titled "Getting Help" in your system's troubleshooting documentation or the section titled "Contacting Dell" in your system's *Help* to find the appropriate telephone number for obtaining customer assistance. If warranty service is required, Dell will issue a Return Material Authorization Number. You must ship the products back to Dell in their original or equivalent packaging, prepay shipping charges, and insure the shipment or accept the risk of loss or damage during shipment. Dell will ship the repaired or replacement products to you (freight prepaid) if you use an address in Canada, where applicable. Shipments to other locations will be made freight collect.



NOTE: Before you ship the product(s) to Dell, back up the data on the hard-disk drive(s) and any other storage device(s) in the product(s). Remove any removable media, such as diskettes, CDs, or PC Cards.

Dell owns all parts removed from repaired products. Dell uses new and reconditioned parts made by various manufacturers in performing warranty repairs and building replacement products. If Dell repairs or replaces a product, its warranty term is not extended.

DELL MAKES NO EXPRESS WARRANTIES OR CONDITIONS BEYOND THOSE STATED IN THIS WARRANTY STATEMENT. DELL DISCLAIMS ALL OTHER WARRANTIES AND CONDITIONS, EXPRESS OR IMPLIED, INCLUDING WITHOUT LIMITATION IMPLIED WARRANTIES AND CONDITIONS OF MERCHANTABILITY AND FITNESS FOR A PARTICULAR PURPOSE. SOME STATES (OR JURISDICTIONS) DO NOT ALLOW LIMITATIONS ON IMPLIED WARRANTIES OR CONDITIONS, SO THIS LIMITATION MAY NOT APPLY TO YOU.

DELL'S RESPONSIBILITY FOR MALFUNCTIONS AND DEFECTS IN HARDWARE IS LIMITED TO REPAIR AND REPLACEMENT AS SET FORTH IN THIS WARRANTY STATEMENT. THESE WARRANTIES GIVE YOU SPECIFIC LEGAL RIGHTS, AND YOU MAY ALSO HAVE OTHER RIGHTS, WHICH VARY FROM STATE TO STATE (OR JURISDICTION TO JURISDICTION).

DELL DOES NOT ACCEPT LIABILITY BEYOND THE REMEDIES SET FORTH IN THIS WARRANTY STATEMENT OR LIABILITY FOR INCIDENTAL OR CONSEQUENTIAL DAMAGES, INCLUDING WITHOUT LIMITATION ANY LIABILITY FOR PRODUCTS NOT BEING AVAILABLE FOR USE OR FOR LOST DATA OR SOFTWARE.

SOME STATES (OR JURISDICTIONS) DO NOT ALLOW THE EXCLUSION OR LIMITATION OF INCIDENTAL OR CONSEQUENTIAL DAMAGES, SO THE PRECEDING EXCLUSION OR LIMITATION MAY NOT APPLY TO YOU.

These provisions apply to Dell's limited one-year warranty only. For provisions of any service contract covering your system, refer to your invoice or the separate service contract that you will receive.

If Dell elects to exchange a product or portion of a product, the exchange will be made in accordance with Dell's Exchange Policy in effect on the date of the exchange. In any

instance in which Dell issues a Return Material Authorization Number, Dell must receive the product(s) for repair prior to the expiration of the warranty period in order for the repair(s) to be covered by the warranty.

“Total Satisfaction” Return Policy (U.S. and Canada Only)

If you are an end-user customer who bought new products directly from a Dell company, you may return them to Dell within 30 days of the date of invoice for a refund or credit of the product purchase price. If you are an end-user customer who bought reconditioned or refurbished products from a Dell company, you may return them to Dell within 14 days of the date of invoice for a refund or credit of the product purchase price. In either case, the refund or credit will not include any shipping and handling charges shown on your invoice. If you are an organization that bought the products under a written agreement with Dell, the agreement may contain different terms for the return of products than specified by this policy.

To return products, you must call Dell Customer Service to receive a Credit Return Authorization Number. Refer to the chapter titled "Getting Help" in your system's troubleshooting documentation or, for some systems, the section titled "Contacting Dell" in your system's *Help* to find the appropriate telephone number for obtaining customer assistance. To expedite the processing of your refund or credit, Dell expects you to return the products to Dell in their original packaging within five days of the date that Dell issues the Credit Return Authorization Number. You must also prepay shipping charges and insure the shipment or accept the risk of loss or damage during shipment. You may return software for refund or credit only if the sealed package containing the diskette(s) or CD(s) is unopened. Returned products must be in as-new condition, and all of the manuals, diskette(s), CD(s), power cables, and other items included with a product must be returned with it. For customers who want to return, for refund or credit only, either applications software or an operating system that has been installed by Dell, the whole system must be returned, along with any media and documentation that may have been included in the original shipment.

This "Total Satisfaction" Return Policy does not apply to DellWare products, which may be returned under DellWare's then-current return policy. In addition, reconditioned parts purchased through Dell Spare Parts Sales in Canada are nonreturnable.

Year 2000 Statement of Compliance for Dell-Branded Hardware Products

Dell-branded hardware products shipped on or after January 1, 1997, are eligible to carry the "NSTL Hardware Tested Year 2000 Compliant" logo by virtue of formal testing with, and successful completion of, the National Software Testing Laboratories (NSTL) YMARK2000 test.* Dell will treat a failure to pass the YMARK2000 test as a covered event under Dell's warranty for the product, subject to the normal warranty limitations.** For a complete copy of Dell's warranty, see the product's documentation. Dell-branded hardware products will also recognize the year 2000 as a leap year.

*The YMARK2000 standard tests the ability of system hardware and firmware to support the transition to the year 2000 (and to recognize leap years, when appropriate, for years 2000 through 2009 inclusive) and not that of options, operating systems, or applications software. Dell-branded hardware products that pass the YMARK2000 test conform to BSI-DISC PD 2000-1.

** Except for this clarification of Dell's warranty for NSTL logo hardware, all other warranties, conditions and remedies, express or implied, relating to year 2000 readiness or compliance are disclaimed. To make a claim under this warranty for NSTL logo hardware, customers must contact Dell prior to January 1, 2001. To make a claim, write to:

Dell Computer Corporation
PO. Box 149258
Austin, Texas 78714-9258
Attention: Year 2000

Despite a system's ability to pass the YMARK2000 test, actual rollover results in specific operating environments may vary depending on other factors including, but not limited to, other hardware, operating systems, and applications software.

Previous Products

For Dell-branded hardware products shipped prior to January 1, 1997, that have an upgradable basic input/output system (BIOS), Dell makes available a BIOS upgrade. Although these products may not have been tested under the YMARK2000 test, Dell believes that the hardware would pass the YMARK2000 test, provided the appropriate BIOS upgrade is properly loaded.

For Dell-branded hardware products that do not have an upgradable BIOS, Dell has made available, as a convenience to customers, the Dell Program Patch, a software utility designed to assist customers in managing the year 2000 rollover.

Software

Dell specifically excludes all non-Dell-developed software from this compliance statement. All software run on Dell-branded hardware products should be independently verified by customers to be year 2000-compliant.

The factory-installed software on your system is the current version provided by the software manufacturer and is validated by Dell for installation. Dell recommends that you check each software manufacturer's year 2000 Web site for updates to their products. Links to a number of these Web sites can be found at the Dell year 2000 Web sites.

Additional Information

For additional information on year 2000 compliance of Dell-branded hardware products, refer to the following Dell year 2000 Web sites, or contact a Dell customer service representative in your area:

- <http://www.dell.com/year2000> (Americas)
- <http://www.dell.com/jp/year2000> (Japan)
- <http://www.euro.dell.com/year2000> (Europe)
- <http://www.dell.com/ap/year2000> (Asia Pacific)

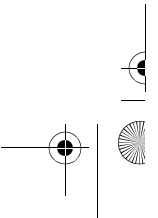
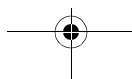
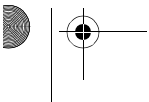
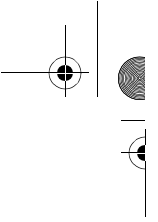

5498T

P/N 5498T Rev. A00



Printed in the U.S.A.



BE DIRECT™
DELL™
www.dell.com

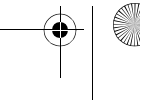
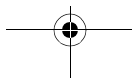
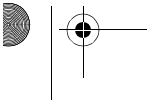
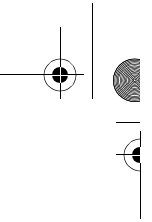

5498T

P/N 5498T Rev. A00

Printed in Ireland.



BE DIRECT™
DELL™
www.dell.com

